

ISSUE #7 JULY 1988

FOR THE RECORD

by Frank N. Zic
(Acting Secretary)

The June meeting of the West Penn 99'ers got off to a late and slow start. More than P-box fans were blowing all night. Once again Jan came through admirably with nice cold fruit salad and what with varied selections of cold soda pop things started humming along. Scott started by commenting that perhaps the Sunday meeting was a short session because of the absence of one; Fathers-Day John. Our meeting started with 22 members and kept growing all night long up to 32 with Jerry bringing up his usual late slot. Since Eric was late, no librarian report was given. The only mention in this area was that the library now has in it a rapid loader for Infocom games. No local newspaper ads were posted since Joe was on vacation. John brought in 19 disks for the library containing mostly Max-Rle pictures. It was stated that Funnelweb Ver 4.1 has now been released. Eric's late note to me said that the following programs have been added to the library: Beethoven Concert, Tass-2001 and TI-Artist's Star Fleet 1,2 & 3.

Jan gave the Treasurers report with a nice balance of \$1058.08 this after paying for 1,000 disks. We wish Scoops a fast recovery from the chills. There was no outstanding old business. Scott gave a rundown on our 5 members that attended the Lima, Ohio Faire. The Faire was sponcered by the (small in number only) 15 membership group. Hats off to a good TI faire put on by a hard working group. John Birdwell's Utility Ver. 4.1 was shown but has not been released to the public. A P-card is for sale for \$80, see Scott. heck the editors section for a listing of local Faires coming up soon. Unfortunately some of us missed notification of the June 5th White Swan Park computer and ham fiest. Gary Taylor demoed Zodiac and Certificate Maker.

I thought the meeting was nearly wrapped up, when I realized that John hadn't spoken yet. He left for a quick 1/2 way trip home to bring back a console for one of our members from Ohio. Now wasn't that nice of John's Wife, who left the swimming pool, to meet him 1/2 way? Well we all just settled back and enjoyed another delightful session of information as only John can present it. He mentioned that good comments were coming in on Norm Rokke's "1000 Words". A program to convert TI-Artist to TI-Writer. Other similar programs take 20 minutes for a conversion while Norm's takes only 1 minute. Nice going Norm. Quickly wrapping up John's session, he demoed; Ghostman, OhMummy, Buzzard, Slymoids, Barrage, Ernie & Bert and Reverse-Rle.

Next were classes on Hardware, held by guess who-John and the TI Tips class by Tom Mainier. A round of applause was given to Mickey Schmitt and Lynn Gardner(absent) when it was announced that their new adventure game "Olivers Twist" was complete and in the hands of Asgard Software and a release date expected this August. Congratulations girls, we all salute you and wish you great success. No more room. May the good 4's be with you.

TREASURER'S REPORT FOR JUNE - 1988

FORTI MUSIC CARD CONSTRUCTION
DETAIL NOW AVAILABLE.

FROM JAN TRAYERS

MIKE DEFRAK HAS COMPLETED A VERY NICE 142 STEP SET OF INSTRUCTIONS ON BUILDING A FORTI MUSIC CARD ON THE PROTOBOARD (COLEMAN/WILLFORTH VERSION). TO GET YOUR COPY SEND A STAMPED SELF-ADDRESSED ENV. TO JOHN F. WILLFORTH, R.D. #1 Box 73A, JEANNETTE, PA 15644. IF YOU WOULD LIKE TWO SSSD DISKETTES WITH A LARGE ASSORTMENT OF CLASSICAL MUSIC (MIKES FORTÉ), PLEASE INCLUDE \$2.00 OR TWO DISKETTES W/SAS MAILER.

I'VE TALKED TO MEMBERS OF THE DALLAS TIUG AND RECEIVED VERIFICATION BY WAY OF A PARAGRAPH IN THE JUNE ISSUE OF MICROPENDIUM, PAGE 42, THAT JOHN P. GUION HAS PLANS TO RELEASE A ROM UPGRADE FOR THOSE WITH TRITON SUPER EXTENDED BASIC WHICH WILL PROVIDE THE USER WITH EDITOR/ASSEMBLER, TI WRITER, AND THE DISK MANAGER III AS WELL AS THE SUPER X BASIC. THE COST WILL BE \$22.95, AND IF YOU ARE INTERESTED, WRITE: JOHN P. GUION, 11923 QUINCY LANE, DALLAS, TX 75230-2651.

MANY OF YOU HAVE READ THAT THE 1-800-TICARES PHONE NUMBER IS ABOUT TO BE DISCONNECTED. I CALLED THE NUMBER RECENTLY TO GET THE INFORMATION ON WHAT NUMBERS WOULD BE USED IN PLACE OF THIS TOLL-FREE NUMBER. I WAS TOLD THAT THE PLANS TO TERMINATE THE NUMBER HAVE NOT BEEN SET YET, BUT WHEN IT DOES HAPPEN, THE FOLLOWING NUMBERS WILL BE AVAILABLE:
806-747-1882.....GENERAL INFORMATION
806-741-2663.....TECHNICAL ASSISTANCE
806-741-2265.....DEALER PARTS
806-741-2268.....DEALER PARTS

SUPPORT FOR ALL PROGRAMMING QUESTIONS WILL CONTINUE WITH THE EXCEPTION OF EDITOR/ASSEMBLER. THIS IS DUE TO INTERNAL PERSONEL.

THE "NEWS LETTER" THE OFFICIAL NEWSLETTER OF THE NEW NINETY NINERS USERS CO-OP, APRIL 1988 ISSUE, CONTAINS TWO VERY INTERESTING HARDWARE ARTICLES. I JUST DON'T HAVE THE SPACE TO PRINT THEM THIS MONTH BUT IF YOU WOULD LIKE THEM SEND A SASE TO MY ADDRESS (SEE THE FIRST PARAGRAPH ABOVE ON FORTI CARD). THE

```

*****
*
* 6/21  CASH ON HAND    $ 45.00  *
*
* 6/21  LIBRARY SALES   18.00   *
*
* "     MICROPENDIUMS   32.50   *
*
*       DISK SALES      40.00   *
*
*       ----- *
*       TOTAL          $135.50 *
*
* 7/06  DEPOSIT         - 90.50 *
*       ----- *
*       CASH ON HAND   $ 45.00 *
*
*****
*
* 6/17  BANK BALANCE    $1476.24 *
*
* 6/17  POSTAGE         _ 103.16 *
*       ----- *
*       1579.08 *
* 6/21  1000 DISKS     _ 315.00 *
*       ----- *
*       1058.08 *
* 7/02  MICROPENDIUM   - 33.00 *
*       ----- *
*       $1025.08 *
* 7/07  DEPOSIT        + 90.50 *
*       ----- *
*       BALANCE        $1115.58 *
*****
*
* TOTAL CASH BALANCE   $1160.58 *
*****

```

FIRST DEALS WITH AN EIGHT (8) CARTRIDGE EXPANDER UNIT THAT USES THE "REVIEW MODULE LIBRARY" FEATURE BUILT INTO THE TI 99/4A CONSOLE FROM IT'S INCEPTION, AND THE SECOND IS BILLED AS THE "TURBO BOOST MODULE", WHICH IS DESIGNED PRIMARILY FOR THE CASSETTE USER. IT'S FEATURES INCLUDE:

- THE TURBO LOADER, 3-4 TIMES FASTER THAN TI
- NAMES PROGRAMS ON CASSETTE
- COMPLETE SUPPORTING OFFILE HANDLING
- UNCLUTTERED SCREEN COMMANDS
- MACHINE LANGUAGE PROGRAMS LOADED
- "MERGE" CAPABILITY IN BASIC

NOTE: THE TURBO BOOST MODULE DOES REQUIRE A SPECIAL ROM TO COMPLETE THE PROJECT, WHICH IS AVAILABLE ONLY FROM MARK KRISTEL, BATTERSTRAAT 170, 1034 BW AMSTERDAM, HOLLAND FOR \$13. INTERNATIONAL MONEY ORDER, THE COMPLETE KIT IS AVAILABLE FOR \$40.

NEXT MEETING OF THE WEST PENN 99'ERS WILL BE HELD AT THE FIRST PRESBYTERIAN CHURCH OF THE COVENANT ON THE CORNER OF 4TH AND OAK STREETS IN DOWNTOWN IRWIN PENNSYLVANIA AT 7:00 PM ON JULY THE 19TH. WE WILL HAVE THE LIMA FAIR VIDEO, THE LATEST VERSIONS OF DISK UTILITY ANF FUTUREWEB 4.1 AND SOME DEMONSTRATIONS. HOPE TO SEE YOU THERE.

J.F.W.

Let's Talk RamDisks Part VII
by John F. Willforth

The Rave 99 "MX01" memory enhancement is a P-Box card which replaces the 32K card and gives you many, varied and useful and unique enhancements in the TI 99/4A system environment. The unit comes in three models:

- MX01/ 64 - contains BK of memory (>6000->7FFF)
BK of non-DSR
BK of system DSR
BK of user DSR
32K of main memory
- MX01/288 - MX01/64 w/224K additional
64k in MX01/64
224K additional.
- MX01/544 - MX01/64 w/480K additional
64K in MX01/64
480K additional.

The MX01/64 is the base unit and it is on this unit that upgrades can be done to the larger two. Rave offers upgrade kits for the two smaller units which consists of the necessary STATIC RAM chips (256K bit low power).

The support power for the MX01 is by either the "super capacitor" that comes with the board and will hold the memory (on the /544 unit) for up to 5 days. If longer protection is required, a 3-volt lithium battery may be installed.

The basic unit cannot be used for the RamDisk application due to the absence of additional RAM. The /288 and /544 do have the additional RAM and using the special DM-1000 supplied with the Ramdisk option as well as a CONFIG program the necessary configuring, volume and file manipulations can be performed. A 1444 sector (DSDD), 360 sector (SSSD), and 119 sector (1/3 SSSD) can be placed on the /544. The /288 unit supports a 720 sector (DSSD), and a 179 sector (1/2 SSSD) pair of Ramdisks. Note that the upcoming PRINT SPOOLER option will probably affect the smallest (1/3 and 1/2) Ramdisk units available in the /544 and /288 because the memory used by these units will be needed by the spooler.

The memory space >6000 to >7FFF can be used by any SuperCart or SuperSpace applications that currently run out of this space.

The non-DSR space is memory space where the Peripheral Device Service Routine is paged into the CPU's own memory. To further explain, most of the computers on the market, require loading a driver program into memory normally used by the CPU to provide the operating system running in the CPU a means to properly control the particular peripheral. This wastes RAM and adds to the cost. TI put no RAM in these areas, but select a ROM based program which is located in a particular controller card such as a disk controller and switches it into this "hole" in memory. This area can have RAM assigned to it and switched in anytime needed or when no DSR is being used.

The fact that the system calls for peripheral DSRs means that you can write your own DSRs for the SYSTEM as well as USER DSRs. The MX01 will allow for you to have these types of DSRs running thus giving you more flexible and varied use of the TI. Special memory mapping of addresses >4000 to >7FFF allows an extra 16K bytes for assembly programs (48K) to be written without any user memory mapping required.

The keyboard macro loader option allows you to assign a single key depression to output for example, a particular string (CTRL-M "PIO"). Macros are not available for basic or extended basic, but will work in programs loaded under option "5" of Editor Assembler, such as TI Writer and many of the terminal emulator programs.

The MX01 can be configured with as many as four (2MEG) in a PEB. You cannot run a TI Thermal Printer, but most everything else, inc. Horizon Ram Disks will work with it.

PRICES:	(upgrades)
MX01/64 199.95	/64 to /288 110.00
MX01/288 309.95	/64 to /544 220.00
MX01/544 419.95	/288 to /544 120.00
Ramdisk software	25.00
Keyboard "MACROS" software	15.00
"PRINT SPOOLER" software	15.00

RAVE 99 Co.
112 Rambling Road
Vernon, CT 06066 (203) 871-7824

32K CONSOLE SINGLE CHIP INSTALLATION
by Ed Hall

This is the way in which I modified my console to add 32K. The modification is based in part on information received from John Willforth. This information included the addressing and data line connections as well as the diode matrixing by Joe Spiegel. In my installation I mounted a socket on top of the ROM chip and connected to it. Due to the physical location of the address pins on the 32K chip, my address lines are not the same as the ones in John's paperwork. I did this so as to have as many connections as possible between the 32K chip and the ROM under it. The end of the 32K chip with pins 14 and 15 is mounted directly on the end of the ROM chip which faces away from the TMS9900. Pin 14 of the 32K matches with pin 12 of the ROM and these are both ground. All pins marked X below are connected between the two chips and all those marked O are jumpered to other points on the board. Pins 1, 2, 27 and 28 are physically located on top of the TMS9900 chip and are all run to points elsewhere on the board. References such as U510 and A15 etc. are from the technical manual for the TI.

Let's move to the actual connections. I chose to make most of my connections to feedthrough points on the board. I've tried to show these connections in the document. I've made them as clear as possible, but I will now attempt to also explain each one. As mentioned above, the X pins are directly connected to the ROM chip. Starting with the first O, pin 1 is connected to a feedthrough point near the pin 15 end of the 32K chip. This runs to U510, pin 13. U510 is a 74LS244 and is located near the I/O connector end of the GROM connector. Pin 2 is connected to a 1K resistor and the anode ends of two diodes (1N914). The cathode ends of the diodes are connected one each to pins 9 and 14 of U504. U504 is a 74LS138 and is located near pin 1 of U510. Pins 11, 12, 13, 16, 17, 18 and 19 are connected to the pads near the GROM connector on the end away from the I/O connector. Pin 15 is connected directly to the GROM connector pin 11. Pin 20 is connected to a 1K resistor and the anodes of four diodes. The cathodes of these diodes are connected one each to pins 7, 9, 10, 14 of U504. Pin 22 is connected to U508, pin 9. U508 is a 74LS04 and is located at the pin 1 end of U504. Pin 23 is connected to a feedthrough point near resistor 525. This resistor runs parallel with the GROM connector near the high even numbered pins. This pad runs to U503, pin 6. U503 is a 74LS367 and is located two chips over from U508. Pin 26 is connected to a 1K resistor and the anodes of two diodes. The cathodes of these diodes are connected one each to pins 10 and 14 of U504. All three 1K resistors are connected to +5 volts on the board. This can be done by connecting them to pin 16 of U504 or pin 14 of U508. Pin 27 is connected to U510 pin 11. Last is the VCC pin of the 32K chip. Pin 28 is connected to the positive end of capacitor C501. C501 is located near the area where the data line jumpers ran and the positive end is towards the GROM connector. This point connects to the VCC pins of the GROM chips.

43256-15L

(pad) FROM U510P13	A15 O--1	28-O VCC	FROM BOARD
DIODES FROM U504P9/14	A2 O--2	3 27-O -WE	FROM U510P11
	A7 X--3	2 26-O A1	DIODES FROM U504P10/14
	AB X--4	K 25-X A6	
	A9 X--5	24-X A5	
	A10 X--6	R 23-O A3	FROM U503P6 (pad)
	A11 X--7	A 22-O -DBIN	FROM U508P9
	A12 X--8	M 21-X A4	
	A13 X--9	20-O CE	DIODES FROM U504P7/9/10/14
(pad) GROM PORT P17	D0 O-11	H 19-O D7	GROM PORT P3 (pad)
(pad) GROM PORT P15	D1 O-12	I 18-O D6	GROM PORT P5 (pad)
(pad) GROM PORT P13	D2 O-13	P 17-O D5	GROM PORT P7 (pad)
	GND X-14	15-O D4	GROM PORT P9 (pad)
		15-O D3	GROM PORT P11

ED. NOTE: THIS ARTICLE COMES TO ME BY WAY OF ED HALL DIRECTLY AND MAKES FOR WHAT I BELIEVE WILL BE A SIMPLER AND CLEANER INSTALLATION OF THE NORMAL MULTIPLEXED 32K MEMORY EXPANSION COMPATIBLE WITH MOST IF NOT ALL SOFTWARE WRITTEN FOR THE TI 99/4A AND USING THE SINGLE 32K STATIC RAM.. TAKE TIME TO READ THE ARTICLE CAREFULLY AND YOU WILL PROBABLY USE THIS AS YOUR GUIDE FOR FURTHER CONSOLE MEMORY INSTALATION. PLEASE BE ADVISED THAT THIS IS IN NO WAY RELATED TO THE 16 BIT MEMORY INSTALLATION DESI'G'N' BY MIKE BALLMAN. ED MAKES LESS HARD WIRE CONNECTIONS BECAUSE HE PIGGY-BACKS THE RAM ON U610 SAVING NEARLY HALF OF THE CUSTOMARY CONNECTIONS. GREAT IMPROVEMENT ED, WHO SAID THERE WAS NO MORE WAYS TO ADD MEMORY TO THE TI CONSOLE.
JOHN F. WILLFORTH

Here's a diagram of the pads I used in the console wiring:
I hope it's clear enough to understand.

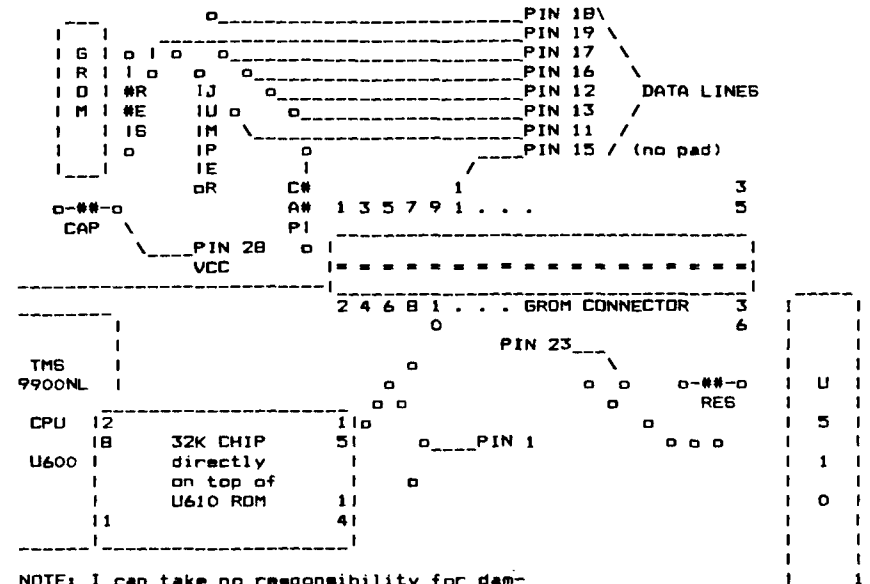

NOTE: I can take no responsibility for damage you create while trying to accomplish this modification. However I will answer your questions if left on Bob & Bill's Bulletin Board(PCPable 202 292 1482) user #50.

#SPECIAL NOTE:

Richard Roseen is presently working on the elimination of some of the diodes. As soon as his modification is completely tested and I get the information I will include it in this file. For now I will only mention his work in this area.

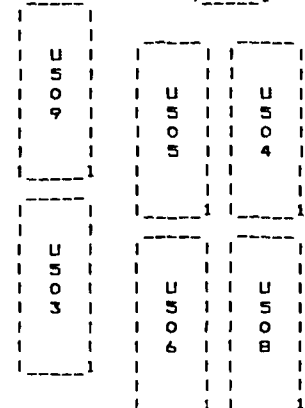

RGB Monitor Interface for the TI99/4A

by Peter Schubert, TISHUG

For those of you who have a RGB colour monitor, or would consider getting one, I have just finished building and testing an RGB interface board that plugs into the standard console and provides outputs for an Analog RGP monitor. It is powered from the 12 volt from the modulator socket, and is simple to build using common transistors (8 off) and resistors. It has adjustable resistors for setting colour saturation and balance. Also included is a simple single chip sound amplifier with volume control. A Printed Circuit Board has been made by club member Leo Gorniak and for details on availability, contact club Director Cyril Bohlsen. This PCB can be mounted into a small plastic box with the 3 inch speaker, or directly inside the Console or Monitor.

This design is based on an idea from a Japanese article by M. Shibuva, circa 1982. It has very good colour purity, and in its present form gives truly exceptional performance, which you will have to see for yourself.

Circuit diagram

Figure 1 shows the complete circuit of the RGB Board. Some monitors may not handle the 'Y' signal from the console directly as was done in this design, and as it is not buffered you will have to remove the 75 ohm termination from the SYNC input of the monitor, as this load is too high for the console video chip output. Figure 2 shows an optional buffer stage that can be added if needed. It requires a 5 volt supply which must be well regulated, and because it must drive a 75 ohm load will draw more current from the console 12 volt than is desired. This is one reason why I did not use it, because it is the 12 volt regulator in the console that makes the console hot.

Adjustment procedure

Adjust the following potentiometers for colour saturation on Primary Colours;

- VR1 - GREEN
- VR3 - BLUE
- VR5 - RED

Start with all three potentiometers fully clockwise (minimum colour) and slowly turn each anti-clockwise to get the colour. Adjust VR2 and VR4 for purity of secondary colours, in particular CYAN and MAGENTA. It may be necessary to repeat the adjustment procedure to obtain true white and grey.

Note: If your monitor has a 75 ohm termination on the SYNC input, this must be removed by opening monitor and cutting out this resistor. (Unless Figure 2 buffer amplifier is used).

continued on page 6

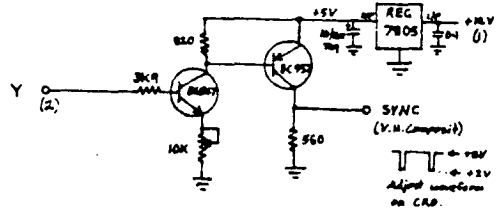
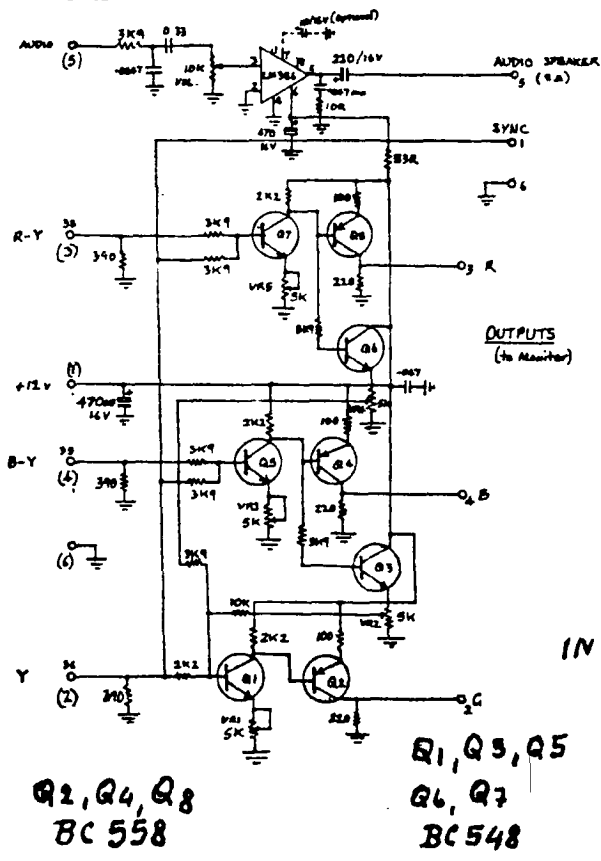

FIG. 2

TI-99 RGB INTERFACE (Analog)

13-3-88 P. Schubert

INPUTS (from Console)



Q1, Q5, Q5
Q2, Q4, Q8
BC 558
Q6, Q7
BC 548

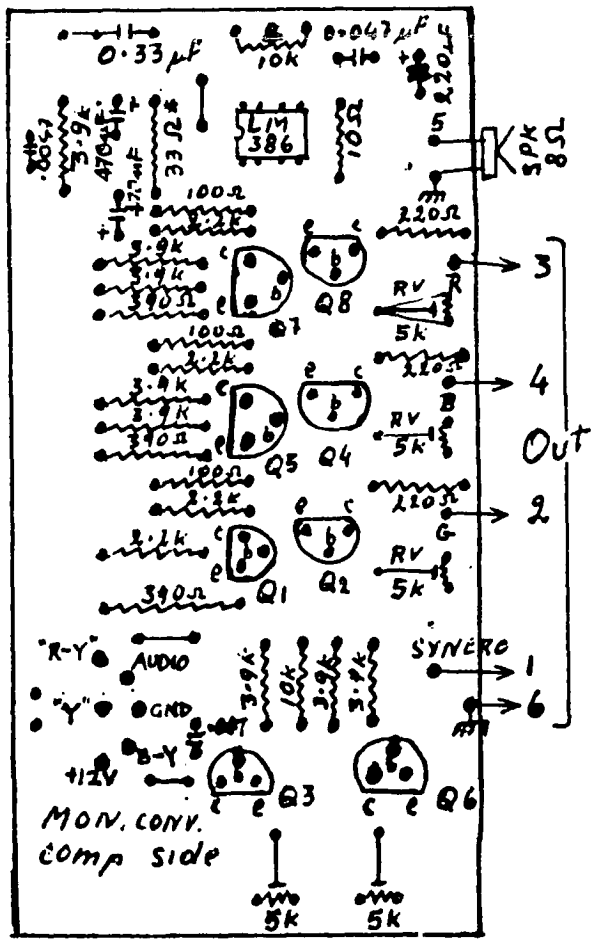

RGB MONITOR INTERFACE (CONT. FROM P.5)

PARTS LIST

QTY.	DISCRIPTION	
5	BC547,548	TRANS. (NPN) Q1,3,5,6,7
3	BC557,558	TRANS. (PNP) Q2,4,8
1	LM386	SOUND IC (OPTIONAL)
1	3" SPEAKER	8 OHM
5	5K OHM TRIMPOT	MINIATURE
1	10K VOL. CONT.	POTENTIOMETER
2	470 MFD 16V.	ELECTROLYTIC CAPACITOR
1	220 MFD 16V.	ELECTROLYTIC CAPACITOR
1	0.33 MFD 25V.	CAPACITOR
2	0.047 MFD 25V.	CAPACITOR
1	0.0047 MFD	CERAMIC CAPACITOR
1	10 OHM 1/4 WATT	RESISTOR
1	33 OHM 1/4 WATT	RESISTOR
3	100 OHM 1/4 WATT	RESISTOR
3	220 OHM 1/4 WATT	RESISTOR
3	390 OHM 1/4 WATT	RESISTOR
4	2.2K OHM 1/4 WATT	RESISTOR
11	3.9K OHM 1/4 WATT	RESISTOR
1	10K OHM 1/4 WATT	RESISTOR

TO THE RIGHT YOU WILL FIND A POSITIVE FOR ETCHING PURPOSES. THE BOARD WILL BE OF COURSE A SINGLE SIDED UNIT WHICH WILL MAKE CONSTRUCTION EASIER. GOOD LUCK! J.F.W.

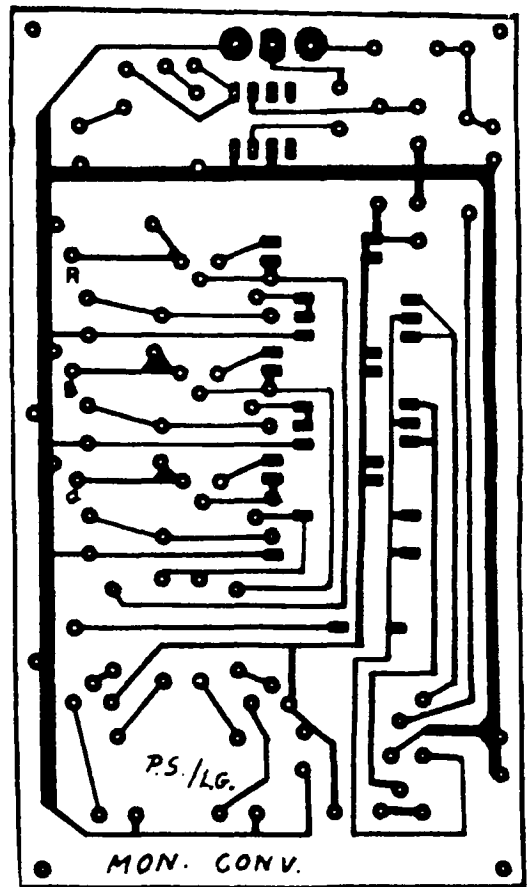

FOR SALE

ALL TI EQUIPMENT, 1) AMDEK COLOR I MONITOR 2) CONSOLE 3) PEB w/32K CARD AND AN AC POWER STRIP. WILL SELL ALL FOR \$200. OR IN PIECES. CONTACT ERIC ZENO (412) 371-4779

FOR SALE

CONSOLE , SPEECH SYNTHESIZER, AND VARIOUS MODULES, CALL FRANK FOSTER (412) 238-7532

WANTED

TI DISK CONTROLLER WORKING. WILLING TO PAY AROUND \$35. CALL PAUL BROCK (412) 478-2754

FOR SALE

1- BOX-CAR STAND-ALONE RS232/PIO UNIT LIKE NEW, ASKING \$60., 1- TI RS232/PIO PEB CARD, ASKING \$55., 1- PANASONIC CASSETTE RECORDER/PLAYER (RECOMMENDED BY TI) ASKING \$20., 1- SPEECH SYNTHESIZER VERY GOOD SHAPE ASKING \$25., I'VE BEEN SAVING TOO MUCH, AND MUST CUT BACK IN THE EXCESS EQUIPMENT I HAVE. CONTACT JOHN WILLFORTH AFTER 9 PM (412) 527-6656.

TALKING TYPEWRITER

FROM THE JUNE ISSUE OF MICROPENDIUM COMES THIS VERY USEFUL PROGRAM FOR THE VERY YOUNG IN THE FAMILY OR IN THE SCHOOL TO HELP THEM LEARN THE ALPHABET. CONTRIBUTED BY ELAINE CHAN PH.D OF SEATTLE WA.

EXTENDED BASIC VERSION DISPLAYS A KEY DEPRESSED IN DOUBLE-SIZED IMAGE IN THE CENTER OF THE SCREEN AND SAYS THE LETTER.

```

100 REM TALKING TYPEWRITER, E
XTENDED BASIC REQUIRED
110 CALL CLEAR
120 CALL KEY(O,K,S)
130 IF S=0 THEN 120
140 IF K>90 THEN 120
150 IF K<65 THEN 120
    
```

```

161 CALL CLEAR
162 CALL SPRITE(#1,K,2,85,120)
164 CALL MAGNIFY(2)
170 CALL SAY(CHR$(K))
180 GOTO 120
    
```

IF YOU WISH TO USE A TE-II CARTRIDGE INSTEAD OF EXTENDED BASIC, THEN REMOVE LINES 162,164,AND 170 AND INSERT :

```

165 CALL HCHAR(12,14,K)
105 OPEN #1:"SPEECH",OUTPUT
170 PRINT #1: CHR$(K)
    
```

PASCAL/p-CODE PART 8
Stan Katzman

There is so much to Pascal that I doubt that I can describe it the the detail that it deserves. So I feel that you should refer to a text that describes Standard or U.C.S.D. Pascal. What I would like to do is to describe some of the programming techniques specific to the U.S.C.D. Pascal system.

If you look at the statements of Pascal you will not see any Read...Data statements like BASIC has. So how do we get data into a program? It enters in two ways 1)from the keyboard and/or 2)from a disk file. The input from the keyboard is for temporary data. The disk file is for permanent data. Attached is a Pascal program which writes and reads a disk file.

We will describe the special U.C.S.D. Pascal statements dealing in file creation.

The type of file must first be identified in the "Var" section. Here we made a "Text" file. A text file can contain letters, strings and real or integer numbers. There are also untyped files called "file" and files of integers. The most common are "Text" and "File".

The program must tell where the file will be located (we put the file on the #5 drive) and the name of the file. The name of the file was done with a "Readln(Fname)" statement. The entire file name was done using the "Concat" statement. The "Concat" is a statement only in U.C.S.D. Pascal. It is a statement that concatenates strings. The entire file name was done in the main body of the program.

In order to write to the file we opened the file for writing using the "Rewrite(f,Filename)" statement and wrote to the file with the statement "Writeln(f,Number[N]);". The "f" says to write to the Text file. When we finish the file is "Close(f,Lock);". If we do not say "Lock" the file is not recorded to disk.

In order to open a file for reading the "Reset(f,Filename);" statement is used. The file must be read as it was created, if one value is written at a time with "Writeln" then one value at a time should be read with a "Readln". When finished the file is closed with "Close(f,Lock);".

If you notice there are "{}". These are comment delimiters. Between these delimiters you can make comments about the program. What appears between the {} is ignored by the compiler.

More next time.

(SEE PROGRAM ON PAGE 8)

FOR SALE:

ALPHACOM-81 AND ALPHACOM-42 THERMAL PRINTERS, WITH INTERFACE FOR THE ALPHACOM-81 FOR \$75. OR B.O. WOULD LIKE TO INVEST IN AN EPSON PRINTER. CALL OR WRITE:
PAUL BROCK 1707 LUXEMBURG MANOR, N. APPOLO, PA 15673 (412) 478-2754

YOU WILL NOTICE THAT I DO NOT PUT EVERYTHING IN ANY PARTICULAR ORDER IN THIS NEWSLETTER, AND BESIDES KEEPING YOU ON YOUR TOES, IT'S EASIER FOR ME TO PUT THINGS WHEREVER THEY'LL FIT. ALSO SOME MIGHT THINK THAT THIS NEWSLETTER IS AS LATE AS IT IS SO THAT YOU WILL HAVE MINIMUM TIME TO FORGET ABOUT COMING TO THE MEETING NEXT WEEK! WELL THAT'S ONE REASON, BUT THE OTHER IS I'VE BEEN INSTALLING SOME BIG-BUCKS COMPUTERS THIS WEEK, AND FEEDING THE FAMILY COMES FIRST.

{S. KATZMAN JULY /9, 1983}
Program Datatest(input,output,f);

1000 WORDS
A REVIEW BY DEANNA SHERIDAN - NORTHCOAST 99ERS
CLEVELAND, OHIO

```
Var
  Fname:String[8];
  Filename:String[12];
  Number:Array[1..10] of Integer;
  f:Text;

Procedure Diskmake;

Var
  N:Integer;

Begin
  For N:=1 to 10 Do
    Begin
      Write(N,' Enter a number > ');
      Readln(Number[N]);
      Writeln;
    End;

  Rewrite(f,Filename);

  For N:=1 to 10 Do
    Begin
      Writeln(f,Number[N]);
    End;

  Close(f,Lock);

  For N:=1 to 10 Do
    Begin
      Number[N]:=0;
    End;

End;(end of diskmake)

Procedure Diskread;

Var
  N:Integer;

Begin
  Reset(f,Filename);

  For N:=1 to 10 Do
    Begin
      Readln(f,Number[N]);
    End;

  Close(f,Lock);

  For N:=1 to 10 Do
    Begin
      Writeln(Number[N]);
      Writeln;
    End;

End;(end of diskread)

Begin(start mainbody)
  Page(Output);

  Writeln('This program writes');
  Writeln('and reads to a disk');
  Writeln;
  Write('Enter a file name > ');
  Readln(Fname);
  Writeln;

  Filename:=Concat('#5:',Fname);

  Diskmake;

  Diskread;

End.(end of main body)
```

Thanks to Jack Sughrue of the M.U.N.C.H. group, who was at the conference in Lima, I was privileged to meet Norman Rokke of the Pittsburgh group who had written a program to meet his needs in his profession. He is a chemistry teacher at a college in Stuebenville and a member of the Pittsburgh group.

He stated he needed a program to do graphics then text, then graphics again and could find none. So he decided to do his own. We all ready have a couple in that class...the Art/Convert by Ann Dhein and enhanced by Triot Software. Rodger Merritt has recently come out with a program with some additional enhancements to do the same thing. These are both Extended Basic programs and take about 20 minutes to convert a TI-Artist instance over to a transliterate file which can be printed by TI-Writer.

If you want to go from graphics to text with both of the above-mentioned programs, it is necessary to prepare your text with a carriage return symbol at the end of each line for it to print properly since you use PIO.CR instead of PIO.LF in order to use the graphics.

1000 WORDS does what the above programs do, only faster and better. It is written entirely in assembly. I have a favorite letterhead I use and decided to test 1000 Words to see how it handled it in comparison to the two programs above. The 20-minutes to convert was suddenly cut to about 1 minute. It was almost unbelievable. When you do your conversion, you are allowed to insert an .IF DSKN. command. I used "header" so that I could go in at any time and "include" whatever file I wanted to immediately follow.

1000 WORDS uses the PIO.LF command, so now I can print my letterhead and have my text follow without any special formatting.

The other two programs use TI-Artist Instances, while 1000 WORDS uses the program format. If you use one file, it will center it on the page automatically. If you desire to use two files for a full-page width, the process is very simple. Create the left side of the page in TI-Artist. Save in the normal manner, only use an "L" as the last letter on your filename. Go to 1000 WORDS and use option 2 which connects two files. It will process this file and create a new file with an "R" extension for RIGHT. Take this file and load it in TI-ARTIST. On the left side of your screen, you will see the ending of the first file with a red line about 1/2 inch wide. Use this as your "ruler" to create the right side of the screen and you can visually see that you have everything set up so that when the two files are put together, they will match perfectly.

Then go back to 1000 WORDS and let it process the two files into a runnable TI-Writer file, and remember this last process will take only a minute or so. You cannot make any changes to this file in the editor and you cannot save it from the Editor without creating havoc. This is stated in documentation. The instructions are easy to follow. There is a sample file included. All I can say is that it is a great program! My \$10.00 is in the mail!! If you like graphics, this program is for you and well worth the asking price.

I continue to be amazed at the things that people are doing with graphics in TI-Writer. Do you realize that the new versions of Wordstar and Word Perfect for those "other" machines are priced at about \$500. TI-Writer, or Funnelweb, is free for most of use and these great enhancements are only \$10 apiece. We need to encourage people to continue to produce items such as this. PLEASE do so when the quality of the work is outstanding. It is in the Cleveland Area User Groups Library and you can also get it from: Norman Rokke, 231 Woodridge Drive, Apt. B204, Wintersville, OH 43952.

THE VCR CONNECTION

By John Parkins - Central Ohio Ninety-niners - March, 1988

Have you ever considered or wished that you could hook up your TI COMPUTER to a VCR? Or have you ever thought about the consequences or effects that you might achieve by doing so? Well, I had in the past, but never quite knew how to do it, or what the effect might be until I tried it. And I liked it! Just think about it for a minute and let your mind wonder with me for awhile, and we'll see what happens.

Let's just assume for instance that you like to play games on your computer. Or, maybe you have a favorite program that you like and run it quite often, such as one of those cartridges like Personal Record Keeping, or one like Tax Investment Records, or Household Budget Management. As a matter of fact, any kind of a program or game that you can think of that will give you a display that shows up on your screen or monitor, whether or not it can be printed out on a printer will be considered here. One might ask by now, what's the point?

My main point is this. Let's take the person that does not have a printer and only uses the console and monitor, or a TV set for the screen. Once you are done with the program and turn the console off, all is lost and gone forever. Right? OK. Now, let's assume that you have, or can get your hands on a VCR, since there are more households that have VCR's for home entertainment than those that have a printer for their 99/4A computer. Anyway, even if you do not have a friend that will let you use theirs, one can be rented from any of several video tape rental places very cheaply when comparing it to buying one. Just make sure it is a VCR (video cassette recorder), not a VTP (video tape player) for the VTP will not record, only play your tape. Now, with a VCR set up in the record mode and hooked up to your computer, everything that is shown on the screen is then captured or recorded on the video tape and can be played back at any other time that may be convenient for you. In doing so, you can immediately view your files or records, or, you can find out by watching the tape how skillful your keystrokes are in a session such as a TYPE TUTOR, etc. With a program such as a typing tutor, there is no way that you can save or record each lesson as you go to enable you to study it later, or be able to analyze your particular situation. Just imagine watching your mistakes as they happen. Seeing is believing, and I'm a believer. The TOUCH TYPING TUTOR cartridge is one that will not save your lessons to either a cassette tape or to a disk drive, much less give you a printout on paper.

Now, maybe you can envision the importance of the VCR in the scope of an analysis in any type of given situation, even those that have the TI P/BOX with all of the cards in it, can and will find a practical use for their VCRs with the TI-99/4A system. The ones that can benefit most are those of you that are operating with only the bare console and a cassette recorder. And by the way, I might add that if you hook your VCR up right, it can entirely replace the need of your old audio cassette recorder. If you save your program on the VCR tape, you will then be able to reload it into the console from the VCR at a later time. Now you can think of all the possibilities of use for it.

THE GOOD PART comes next!

I can hear the questions rattling in your mind! How in the world can I get mine hooked up? If you are truly interested, read on! If not, you can skip the rest.

I noticed that my VCR had four RCA jacks on the panel, one for video input, one for audio input, one each for video audio output. I had all ready inspected and repaired my video modulator when it malfunctioned and was familiar with what was inside that little box that hangs from the back of the TV. I knew it had a video and audio and the ground connections inside. That's where I had to make the repair to the broken wire. I'm not digressing here, only letting you know how I stumbled onto this in the first place. I had some old 8mm movies of the children taken in the 50's that I wanted to convert to VHS and make copies for the children. A very dear friend and computer enthusiast of mine, Jack Montag, a professional photographer, agreed to make the conversion for me. Another friend in the club, Frank Skinner, had purchased a program from J&KH SOFTWARE called Video Titles II which will make automated sequences of custom titles for in-store advertising or video recordings. Frank had used this program to make a title display for his Computer Robotics Business with great success. I borrowed this program and generated some fancy titles for my homemade movies. My next step was to make a cable to connect it all together. Needed was a plug that was on a spare video modulator from Radio Shack. Now, all I had to do was desolder the plug from the wires. Next, I found a pair of jumper wires with RCA phono plugs on both ends. One happened to be red and the other black. I cut the plugs off of one end of each cable and stripped the insulation back to expose the wrapped shielded wire and the inside solid wire of each cable where the old RCA phono plug was.

I then twisted and soldered the shielded wires of both red and black cables together. This left the center wire of each cable to be dealt with. (This one has the small plastic covering on it. Trim only a small portion of this plastic off of each cable so that only a very short portion of wire is extending from it. The next step is to find your plug from the old video modulator. If you were to hold the plug in your hand and look into the open end, you would see 5 pins, arranged in what could be determined to look like a (happy face without eyes). The pin arrangement makes the big smile. Looking at them from right side to the left, we will call the right-most pin #1. It is the audio pin, where the red audio wire is to be soldered to. The very center or bottom pin is the common ground, where the twisted shielded pair is to be soldered to. The black wire is the only remaining wire and is to be soldered to pin #4, located just to the left of the center pin. This is the video pin. After the solder joints have been completed, replace the plug hood and it is ready for use. Just plug this plug into your console, and place the other ends into your VCR where the black RCA phono plug goes into the Video-In Jack and the red RCA phono plug goes into the Audio-In Jack of the VCR. From the VCR, you then connect your regular cable from VCR to the TV in the normal manner. (This would depend on the type of connectors whether they be twin flat leads or cable-ready which uses the 75 Ohm resistor.)

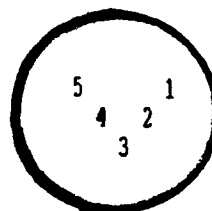

- #1 AUDIO-OUT
- #2 NOT USED
- #3 COM-GROUND
- #4 VIDEO-OUT
- #5 NOT USED

SUPER EXTENDED BASIC OWNERS!
Have four modules in one with:
MULTI-MOD

The MULTI-MOD is an upgrade kit for owners of Triton's Super Extended BASIC module that provides Editor/Assembler, Disk Manager III, and TI-Writer in addition to Super Extended BASIC. Once installed, the MULTI-M' will allow the user to select any of the four modules from the TI menu screen. Selecting any module is just a matter of pressing a couple of keys. No switches, cartridge expanders, or swapping of modules is required.

Not only does the MULTI-MOD save wear on the module port, fewer operating errors caused by poorly seated modules will result. The need for cartridge expanders can be eliminated, contributing to the ease of typing. Since all four modules can be accessed by the computer, the MULTI-MOD also allows the user to write programs that access the capabilities of the other modules.

The MULTI-MOD is completely compatible with the original Super Extended BASIC. The Editor/Assembler and TI-Writer provide all the functions of the original modules while the Disk Manager III provides convenient enhancements to the Disk Manager II module. With the new Disk Manager, drives up to an including DSK9 may be accessed as either single or double sided and single or double density. Help screens with complete listings of error codes are available and the PIO printer port is now selectable as a menu option. The Disk Manager is compatible with TI, CorComp, or Myarc disk controllers.

The only tool needed to install the MULTI-MOD upgrade kit is a flat-blade screwdriver (used to open the module case and remove chips). The MULTI-MOD plugs into existing sockets and no soldering is required. An illustrated installation guide is included in the MULTI-MOD manual. The MULTI-MOD may ONLY be used in a Triton Super Extended BASIC module.

The MULTI-MOD kit includes the MULTI-MOD upgrade, an instruction manual describing how to use the MULTI-MOD's features, and one diskette with the necessary support files for Editor/Assembler and TI-Writer. (Note: Complete manuals for the additional modules are not included with the MULTI-MOD. These are available from Texas Instruments.)

To order, send \$22.95 (cash or check, please) to:

John Guion
11923 Quincey Lane
Dallas, TX 75230

(Super Extended BASIC is a trademark of Triton Products Company)

WEST PENN 99'ERS

% John F. Willforth
R.D. # 1 Box 73A
Jeannette, PA
15644

JULY 1988 ISSUE

NEXT MEETING JULY 19th
First Presbyterian Church
of the Covenant at 7:00 PM
(corner 4th and Oak Irwin, PA)

EDMONTON 99'ers
P.O. BOX 11983 EDMONTON
ALBERTA, CANADA, T 5J3L1

