

① SPACE PADS FOR 1/4W RESISTOR - FOR ECD USE ONLY

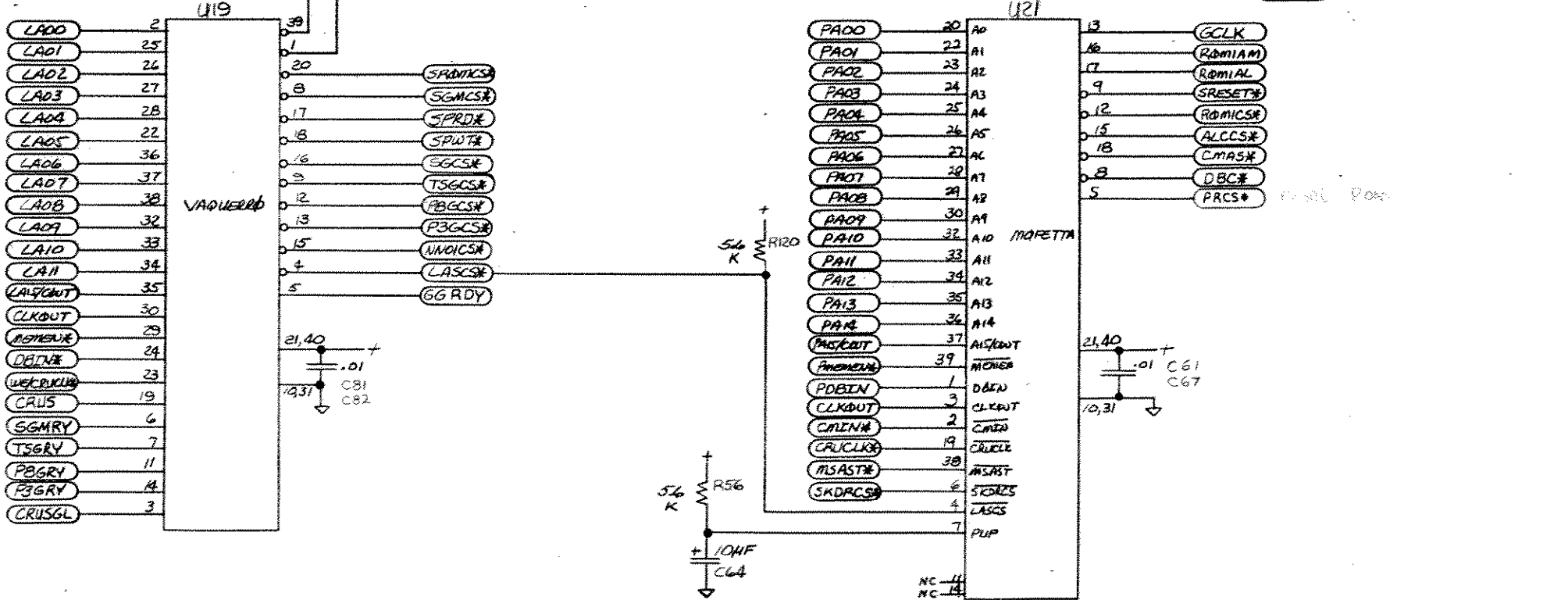

ICLD

DIMENSION IDENT. NUMBER	
USED	NOT USED

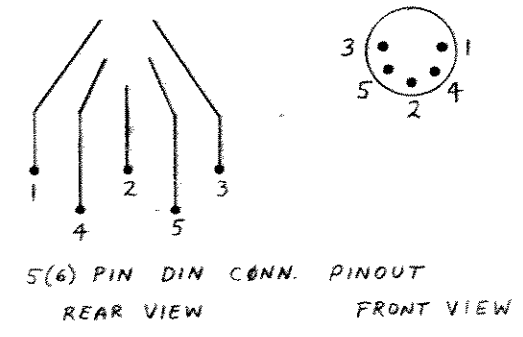

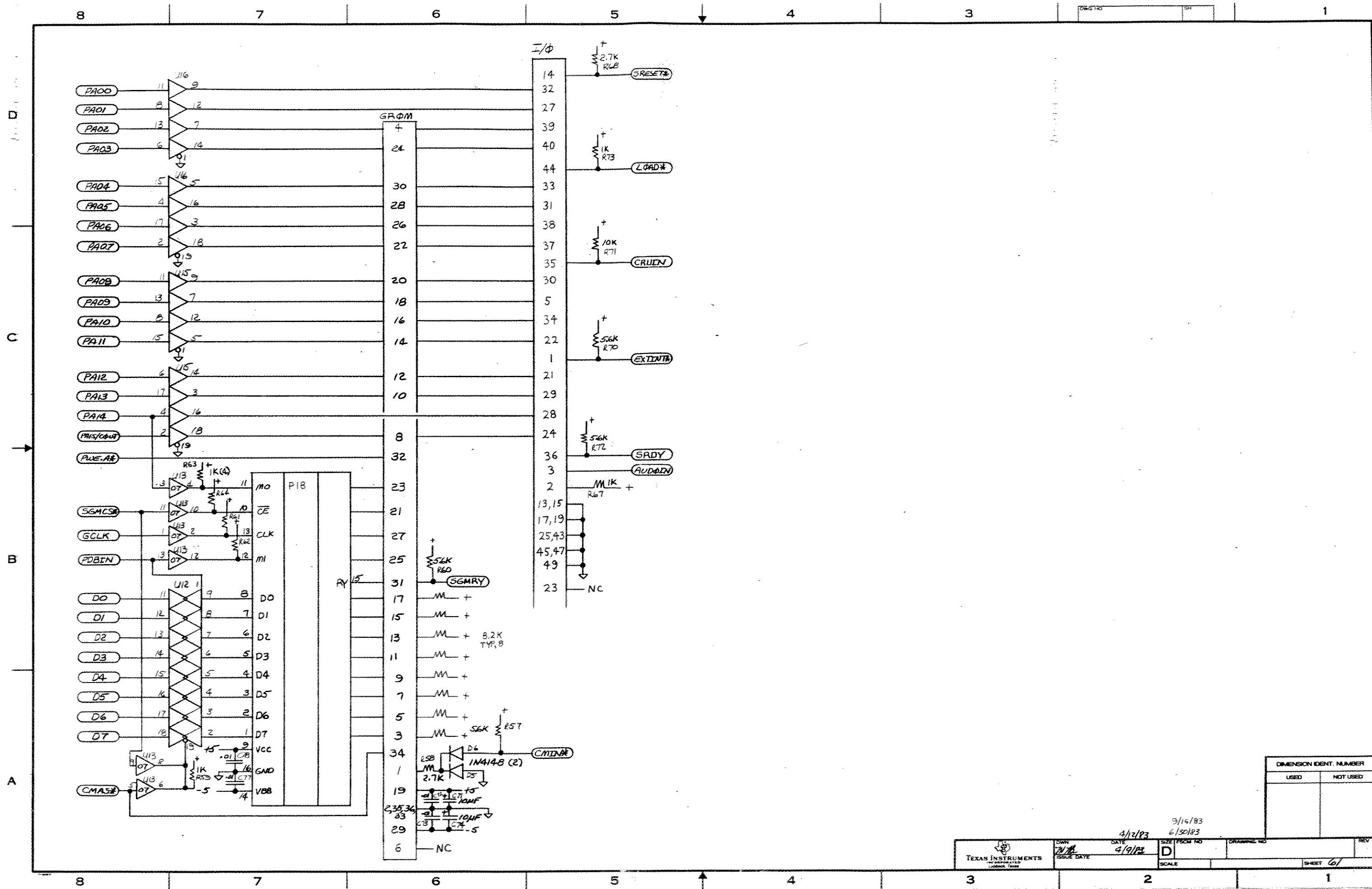

DIMENSION IDENT. NUMBER	
USED	NOT USED

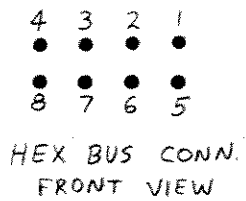
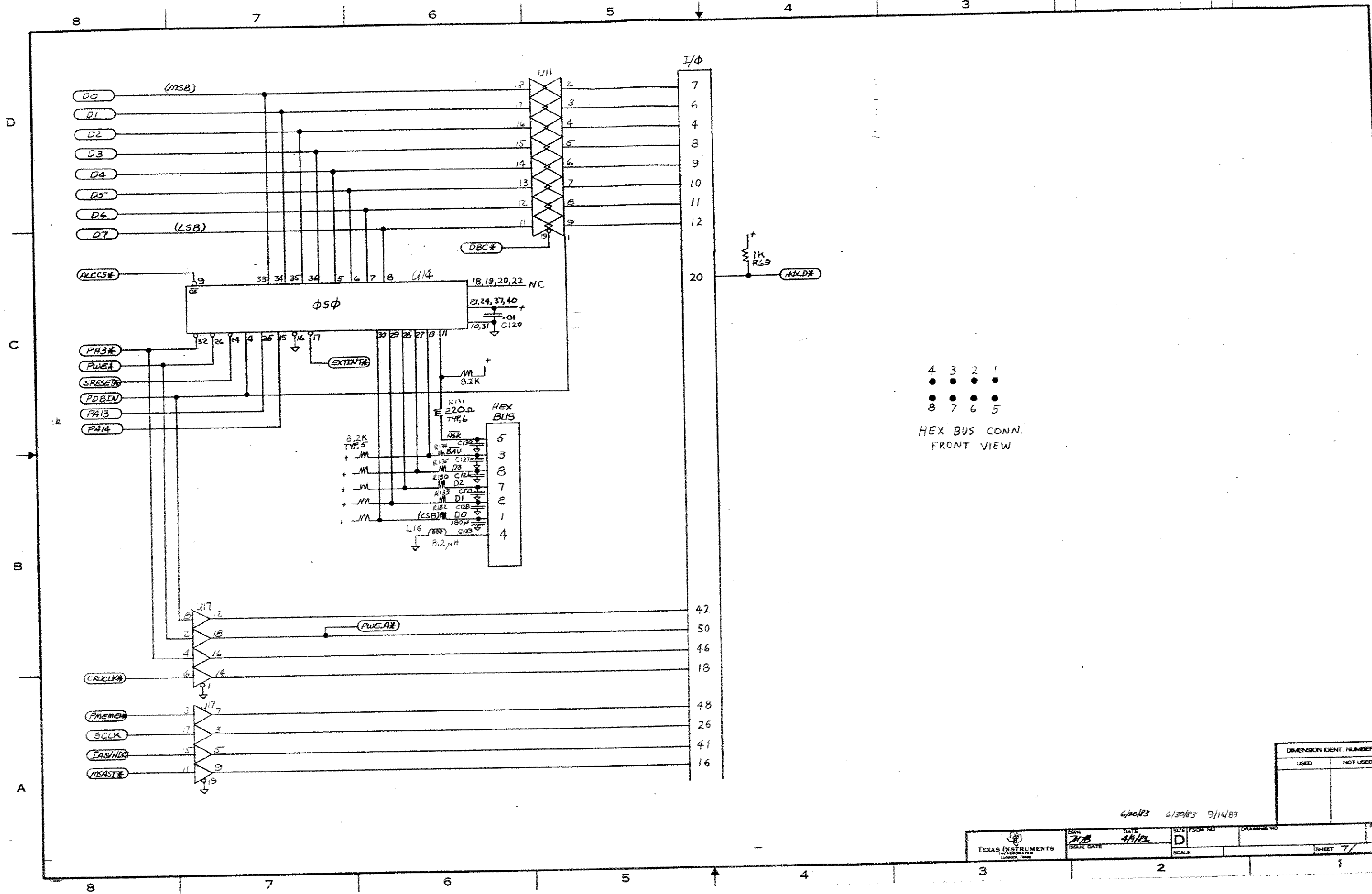

DIMENSION IDENT. NUMBER	
USED	NOT USED

6/20/83	6/30/83	9/14/83
DWN <b>JTB</b> ISSUE DATE	DATE <b>4/1/82</b>	SIZE (PDSM NO) <b>D</b> SCALE
TEXAS INSTRUMENTS INCORPORATED LONDON, ENGLAND		DRAWING NO. SHEET <b>7/7</b>

8

7

6

5

4

3

1

DWG NO. SH

D

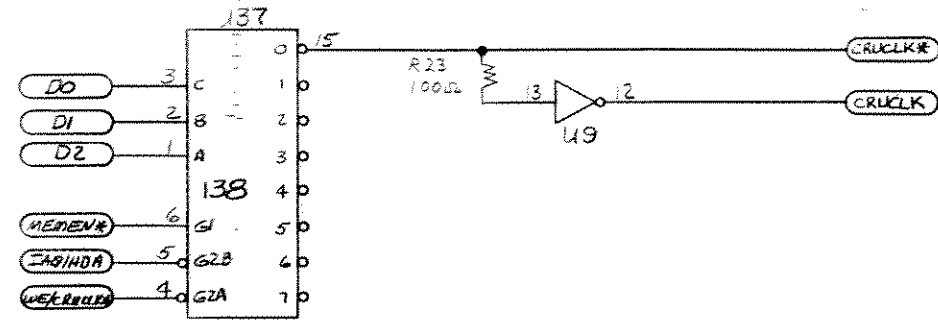

C

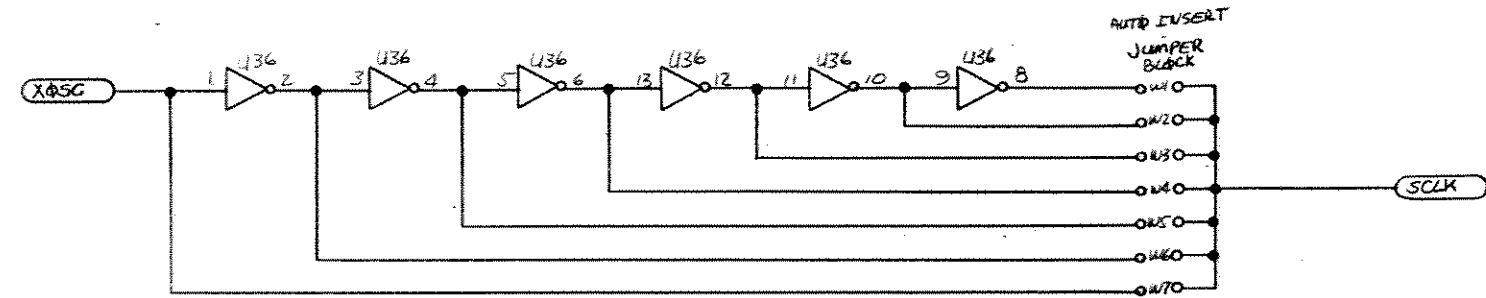

B

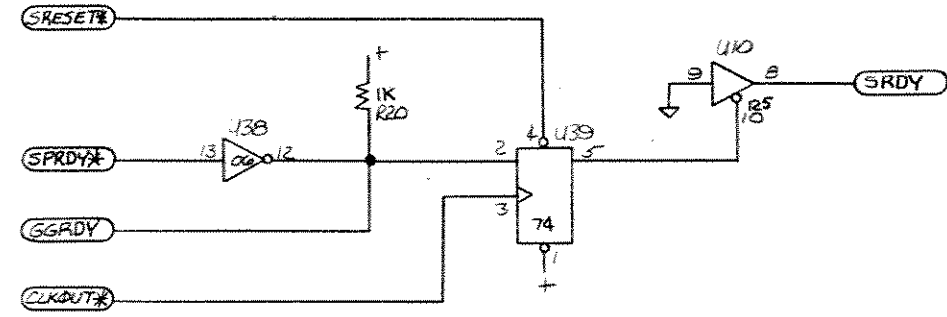

A

DIMENSION IDENT. NUMBER	
USED	NOT USED



